



The launch of .eu

Brussels, 10/10/2005





Message

- .eu is around the corner
 - Launch 7 DECEMBER 2005 !!
- a EUROPEAN (INTERNET) IDENTITY for everybody
- Be prepared : first-come-first-served
 - Know what to do
- Unique Protection of domain name holders
 - Sunrise period
 - Alternative Dispute Resolution
 - Controled procedures for transfer of domain names

What is a domain name

Computers connected to the internet have an IP address

146.48.98.96

www.eurid.eu

DOMAIN NAME SYSTEM

Much easier !!



What is a domain name

- An easy to remember internet address
 - website
 - E-mail
- ↓
- A digital brand == high commercial value

 - EC : .eu for a European Internet Identity



HISTORY

- o Initiative taken by EC in 1999
- o February 2000 : start of public consultation
- o Incorporated in the eEurope initiative
 - o *Accelerating e-commerce*
 - o « The Commission will support a .eu top level domain to encourage cross-border electronic commerce within the EU ... »
- o Regulation 733/2002 created the legal framework (22 April 2002)
- o Request for Expression of Interest
 - o EURid chosen

WHO is EURid?

○ **EU**ropean **R**egistry for **I**nternet **D**omains

« ... a registry focused organisation based on the relevant experience from these organisations to run such a registry in a real not-for-profit spirit ... »

❖ Founding members :

- DNS Belgium (registry of .be),
- Istituto di Informatica e Telematica (registry of .it)
- NIC SE (registry of .se)

❖ Effective members :

- CZ NIC (registry of .cz)
- Arnes (registry of .si)

Know what to do

THE EURid MODEL

ACTORS



EUR*id*

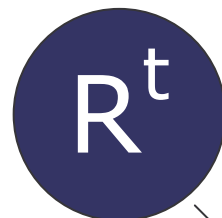

List on www.eurid.eu
Per language
Per country



EURid MODEL

- o Based on the legal framework set out by the EC
 - o Regulation 733/2002
 - o Regulation 874/2004
laying down the public policy rules concerning the implementation and functions of the .eu Top Level Domain and the principles governing registration
- o First-come-first-served
 - o Exceptions
 - o **Reserved lists (countries, EC, registry)**
 - o **Blocked lists (names that are not allowed at 1st level)**
 - o **Phased registration (sunrise)**
 - o **2 letter names representing cc**
 - o All other names are allowed ; no proof needed after sunrise



EURid MODEL

- o No direct registrations, only via registrars
 - o [Pre-payment model for registrars]
- o 1 year term
- o Automatic renewals
- o Protecting the end-users with specific transfer procedures
- o Alternative Dispute Resolution
- o Completely automated system

How to register a domain name

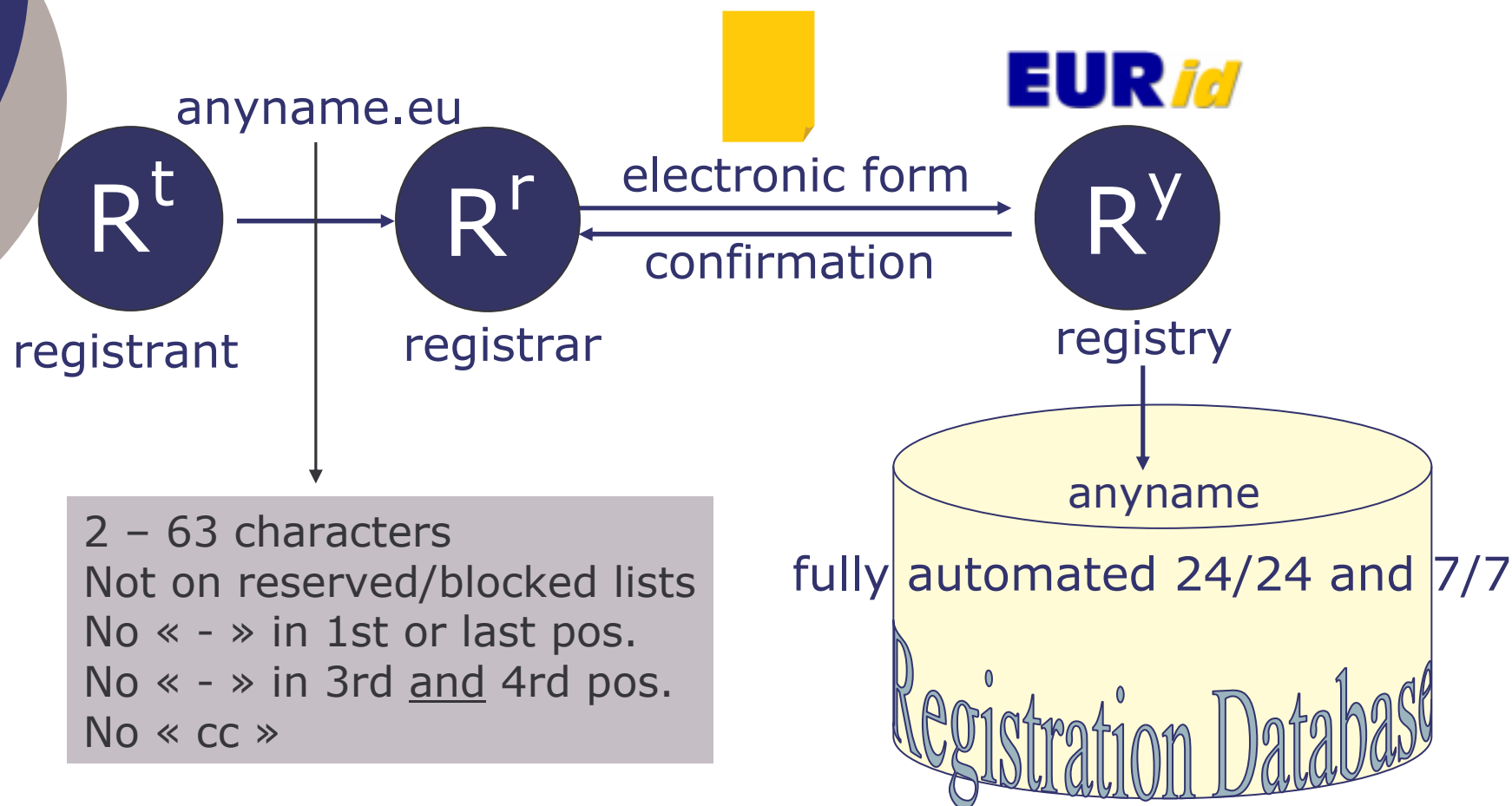

Who can register a .eu name ?

- Only following legal or a private persons can register a .eu domain name :
 - an **undertaking** having its registered office, central administration or principal place of business within the Community, or
 - an **organisation** established within the Community without prejudice to the application of national law or
 - a **natural person** resident within the Community.

(Commission Regulation 874/2004)

A unique set of protections

PROTECTING THE END USERS

A UNIQUE SET OF PROTECTIONS

- Phased registration period
- Alternative Dispute Resolution Procedure
- Strict procedures for transfers

PHASED REGISTRATIONS

- **What ?**
 - A period of 4 months during which only holders of a prior right can apply for a domain name

- **Why ?**
 - To offer those with prior rights the opportunity to protect their names

 - To prevent the abuses witnessed in .com and others

 - To ensure a quality domain name and enhance the reputation of .eu



2 PHASES

- o Phase I :
 - o registered trademarks, geographical indications and designations of origin, Public Bodies

- o Phase II :
 - o Type of rights : names that can be applied for during phase 1 + all other prior rights
 - o trade names,
 - o company names
 - o business identifiers
 - o Literary works
 - o
 - o as far as protected under the national law of the Member State where they are held)

A UNIQUE APPROACH

- o All applications during sunrise will be validated by IP specialists
 - o Partners :
 - o PricewaterhouseCoopers (« **Validation Agent** »)
 - o For Public Bodies : 1 Governmental Validation Point per country (**GVP**)
- o Full transparency !!

SUNRISE ACTORS

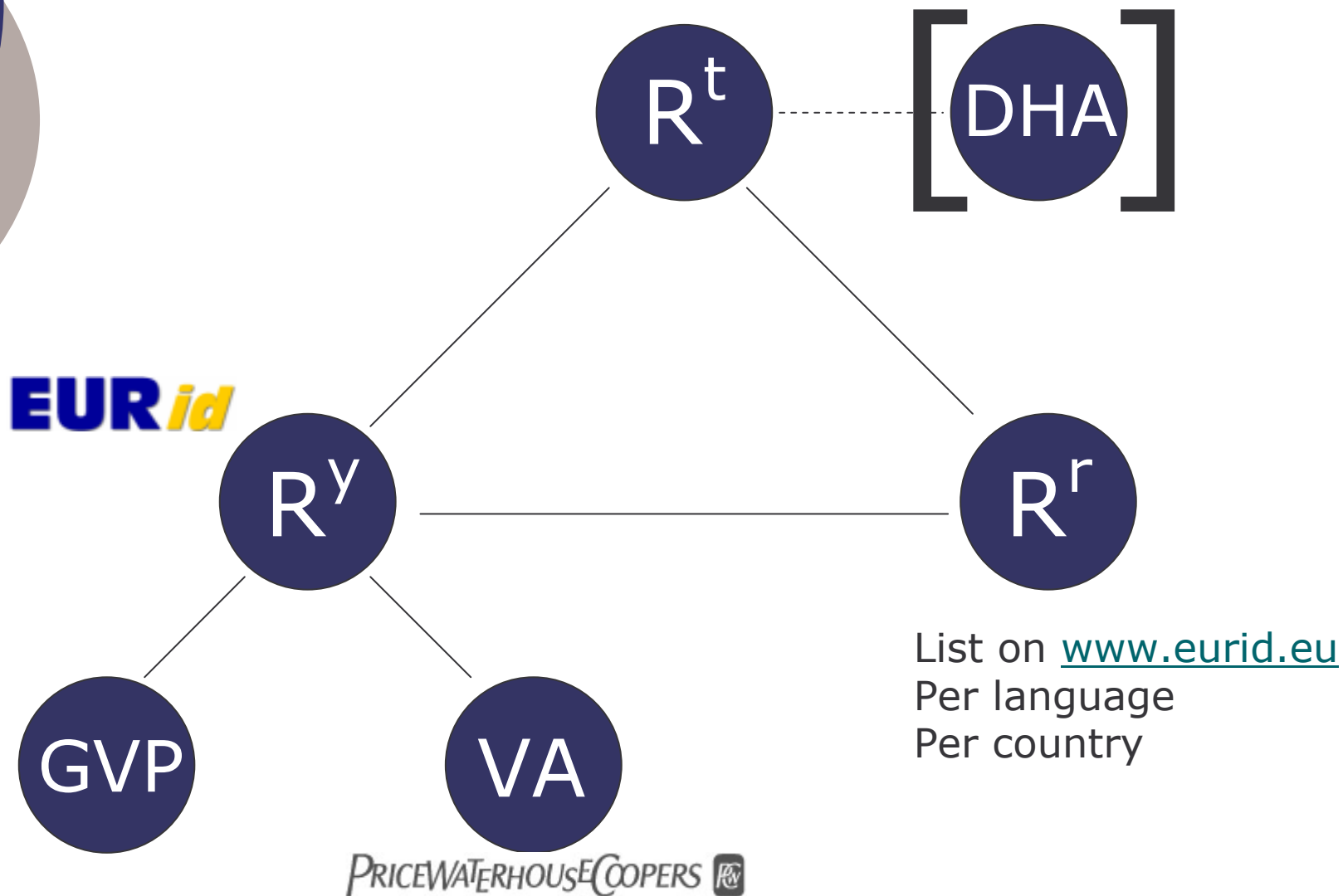

IMPORTANT: Do not staple, attach or bind documents, as these may be rejected by the Validation Agent submit only A4 documents, printed on one side only

To:

Béta
Main Street, 45
099 Topcity
Netherlands

| | |
|---|------------------------|
| Date of application | September 15, 2005 |
| Name of Applicant ("Applicant") | Béta |
| Domain name applied for ("Domain Name") | plex.eu |
| Name for which a prior right is claimed (1) | plex |
| Type of prior right claimed | COMP-IG in Netherlands |
| Documents must be received by Validation Agent by | October 31, 2005 |

Dear Sir or Madam,

.eu Sunrise Declaration - plex.eu

Further to the application for the Domain Name referred to above, please find enclosed the documentary evidence substantiating the existence of the prior right claimed over the name referred to under (1) ("the Claimed Prior Right"). This documentary evidence is provided to you in order for you to validate such Claimed Prior Right, as set forth in the EU Regulations concerning the .eu Top Level Domain.

Representations, warranties and disclaimer

- The undersigned is the Applicant and has obtained all necessary powers to legally commit the Applicant in this respect.
- The Applicant meets the requirements set forth in Article 2(b) of Regulation (EC) No. 733/2002 of 22 April 2002 on the implementation of the .eu Top Level Domain. [\(include hyperlink to page\)](#)
- The Applicant is the owner, holder or licensee of the Claimed Prior Right, and is of the opinion that it is entitled to apply for the Domain Name on the basis of such Claimed Prior Right during the phased registration period.
- On the date and on the Date of Application, the Claimed Prior Right was a legally valid right for which all legal and administrative formalities and requirements had been complied with and, where applicable, for which the necessary taxes and fees had been paid in due time.
- The documentary evidence attached hereto is true and genuine copies of the original documents and provides proof of the existence of such Claimed Prior Right, is complete, accurate, up to date and not fraudulent, and drawn up in accordance with the Registration Terms and Conditions, as set out at [\(http://to be included\)](#), and contains all the elements required therein.
- The Registration Terms and Conditions ([http://to be included](#)), including the special terms that relate to the phased registration period apply ([http://to be included](#)) and have been read and approved by the Applicant without reservation, and the provisions on limitation of liability and privacy (data protection).
- The Applicant has understood that any breach of the Registration Terms and Conditions, including their annexes, can result in the application for the Domain Name or cancel the registration thereof.

Signed by: _____
Position: _____
Date: _____

(hand-written signature must be preceded by the words "read and approved")



2582100080339999



Register a domain name

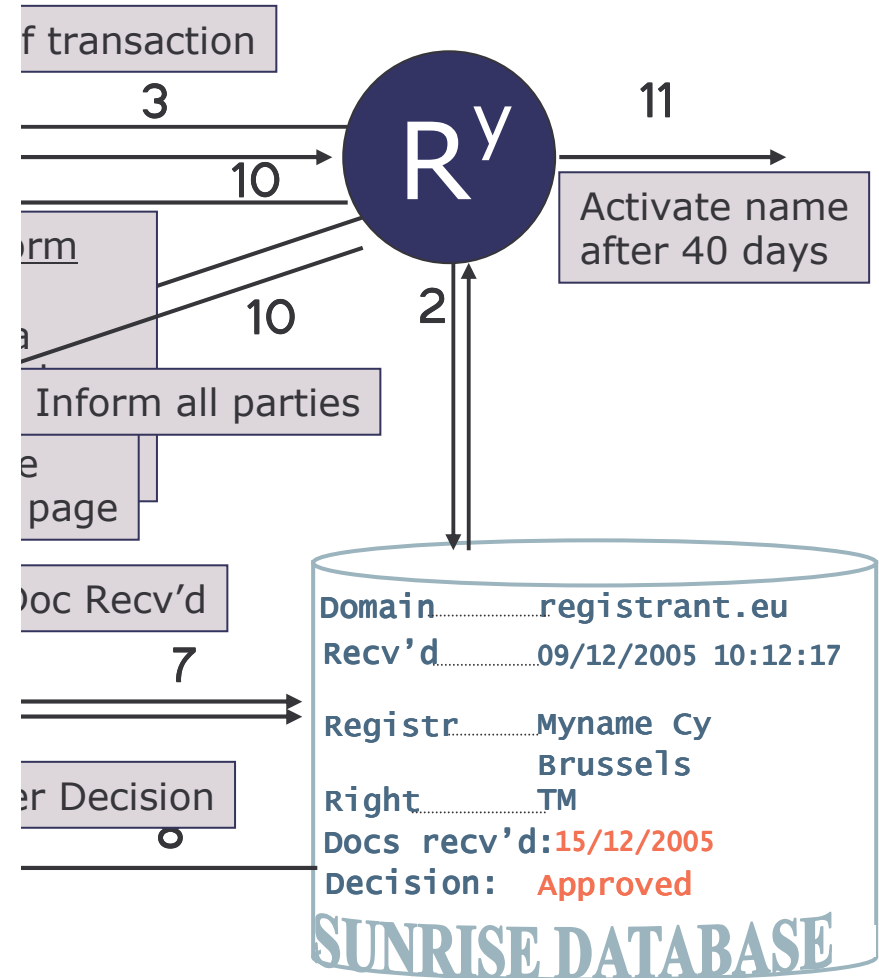

SUNRISE : Role of the Registrant

- o Name to be registered
 - o Requested name should correspond exactly with name for which right is claimed
 - o Spaces = omitted or replaced by « - »
 - o Other characters (@,&^,;,...) = omitted, replaced by « - » or transcribed
- o Contact data
 - o PRIVATE <> COMPANY !!
 - o Working (!) e-mail address
- o Prior right claimed
 - o Original name
- o Who will do the paperwork
 - o Registrant / Registrar / Third Party (Document Handling Agency)

SUNRISE : Role of the Registrar

- o Sends electronic form with application from Registrant → Registry
- o Must present T&C
- o Pre-pay
- o **Language of contract !!**

SUNRISE : F-C-F-S applies !

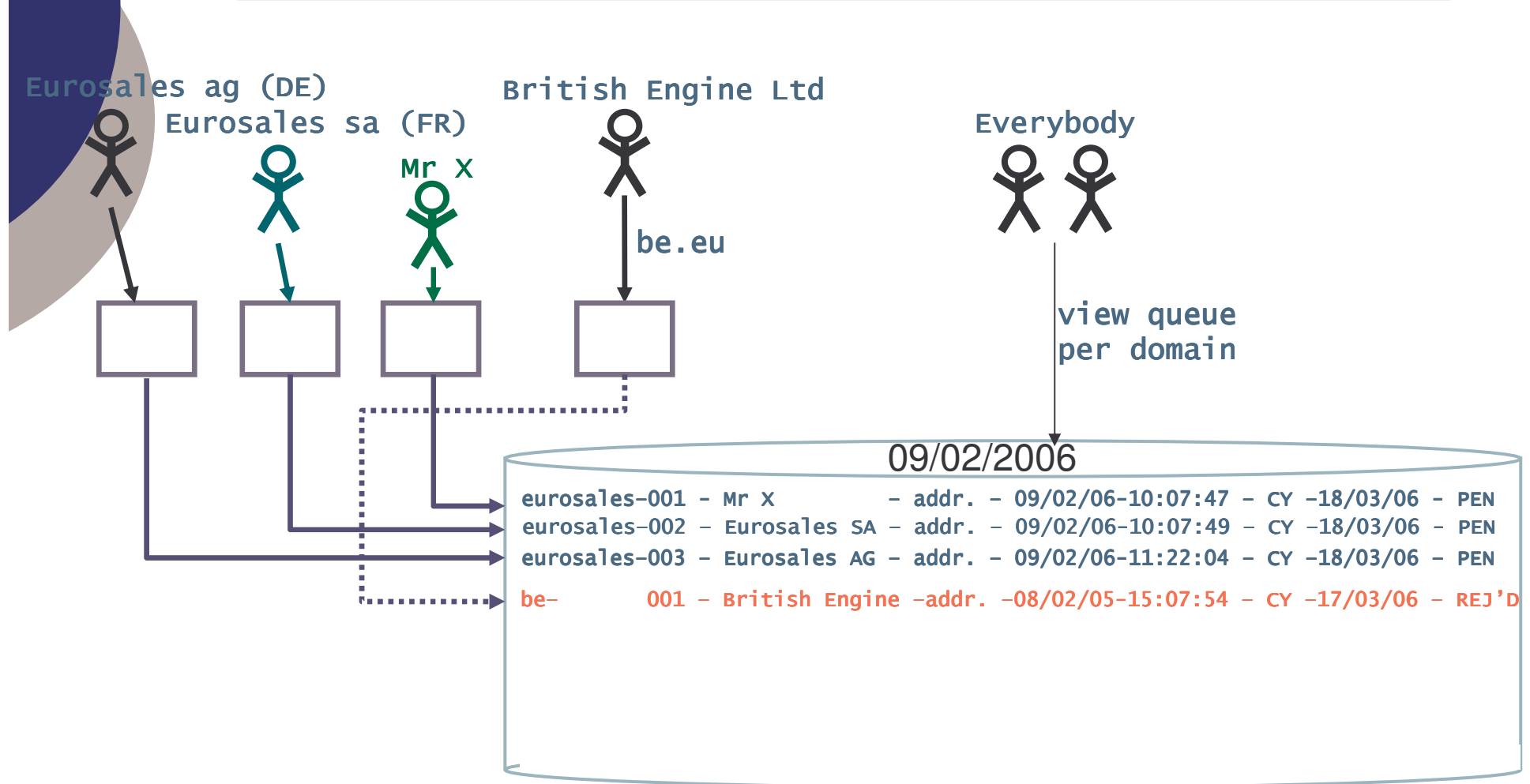

FULL TRANSPARENCY !

Domain name: eurosales.eu

clickable

Name : Mr. X
 Company : -
 Address : Main Street, 5
 1000 Brussels
 Country : Belgium
 E-mail : mr-x@best.com
 Tel. : +32 12 345678

| Order in queue |
|----------------|
| 1 |
| 2 |
| 3 |

| work d | right claimed | status | Application number |
|--------|---------------|---------|--------------------|
| | CY | pending | 0015435 |
| | CY | pending | 0015489 |
| 06 | CY | pending | 0015639 |

Entered by the system (+ 40 days)
 (electronic) application form

- Entered by the Validation Agent
- Not publicly visible

FULL TRANSPARENCY !

Domain name: eurosales.eu

Date : 27/02/2006

| Order in queue | Time/date Received | applicant | Deadline for paper work | Paper work received | right claimed | status | Application number |
|----------------|--------------------|------------------------------|-------------------------|---------------------|---------------|---------|--------------------|
| 1 | 09/02/06-10:07:47 | Mr. X | 21/03/06 | - | CY | pending | 0015435 |
| 2 | 09/02/06-10:07:49 | Eurosales SA | 21/03/06 | 25/02/06 | CY | pending | 0015489 |
| 3 | 09/02/06-11:22:04 | Eurosales AG | 21/03/06 | 12/02/06 | CY | pending | 0015639 |

This name will not be evaluated because deadline for entering documentary evidence for first on the list has not expired.

FULL TRANSPARENCY !

Domain name: eurosales.eu

Date : 22/03/2006

| Order in queue | Time/date received | applicant | Deadline for paper work | Paper work received | right claimed | status | Application number |
|----------------|--------------------|------------------------------|-------------------------|---------------------|---------------|---------|--------------------|
| 1 | 09/02/06-10:07:47 | Mr. X | 21/03/06 | - | CY | EXPIRED | 0015435 |
| 2 | 09/02/06-10:07:49 | Eurosales SA | 21/03/06 | 25/02/06 | CY | pending | 0015489 |
| 3 | 09/02/06-11:22:04 | Eurosales AG | 21/03/06 | 12/02/06 | CY | pending | 0015639 |

The first on the list did not enter his documents within the required period

→ evaluation starts with next in the list : Eurosales SA

FULL TRANSPARENCY !

Domain name: eurosales.eu

Date : 25/03/2006

| Order in queue | Time/date received | applicant | Deadline for paper work | Paper work received | right claimed | status | Application number |
|----------------|--------------------|------------------------------|-------------------------|---------------------|---------------|----------------|--------------------|
| 1 | 09/02/06-10:07:47 | Mr. X | 21/03/06 | - | CY | EXPIRED | 0015435 |
| 2 | 09/02/06-10:07:49 | Eurosales SA | 21/03/06 | 25/02/06 | CY | APPROVED | 0015489 |
| 3 | 09/02/06-11:22:04 | Eurosales AG | 21/03/06 | 12/02/06 | CY | NOT CONSIDERED | 0015639 |

When approved, all remaining applications are automatically invalidated.

Approved name is registered after 40 day waiting period.

ALTERNATIVE DISPUTE RESOLUTION

- o During sunrise
 - o An applicant can start an ADR when he does not agree with the decision taken by the Registry/VA

- o After sunrise
 - o An applicant can start an ADR against a domain name holder who has registered a name on which the complainant has a prior right

ADR Timeline

complaint filed
+ fee paid



ADR provider : inform domain name holder + domain name suspended

- 1 ADR provider : check administrative compliance
- 2 domain name holder : time to respond
- 3 panel to decide
- 4 ADR provider : communicate decision to parties
- 5 parties : time to initiate court procedure

Days = working days

COST OF .eu NAME

- o Sunrise Application :
 - o handling costs : 15 €
 - o Validation costs :
 - o 20 € (public bodies)
 - o 30 € (trademarks)
 - o 70 € (other)
- o Registration 10 €
- o Validation fee for non-validated applications will be returned to registrars
- o Special fees for transfers / reactivates etc.

TIMELINE OF THE LAUNCH

Announcement of sunrise

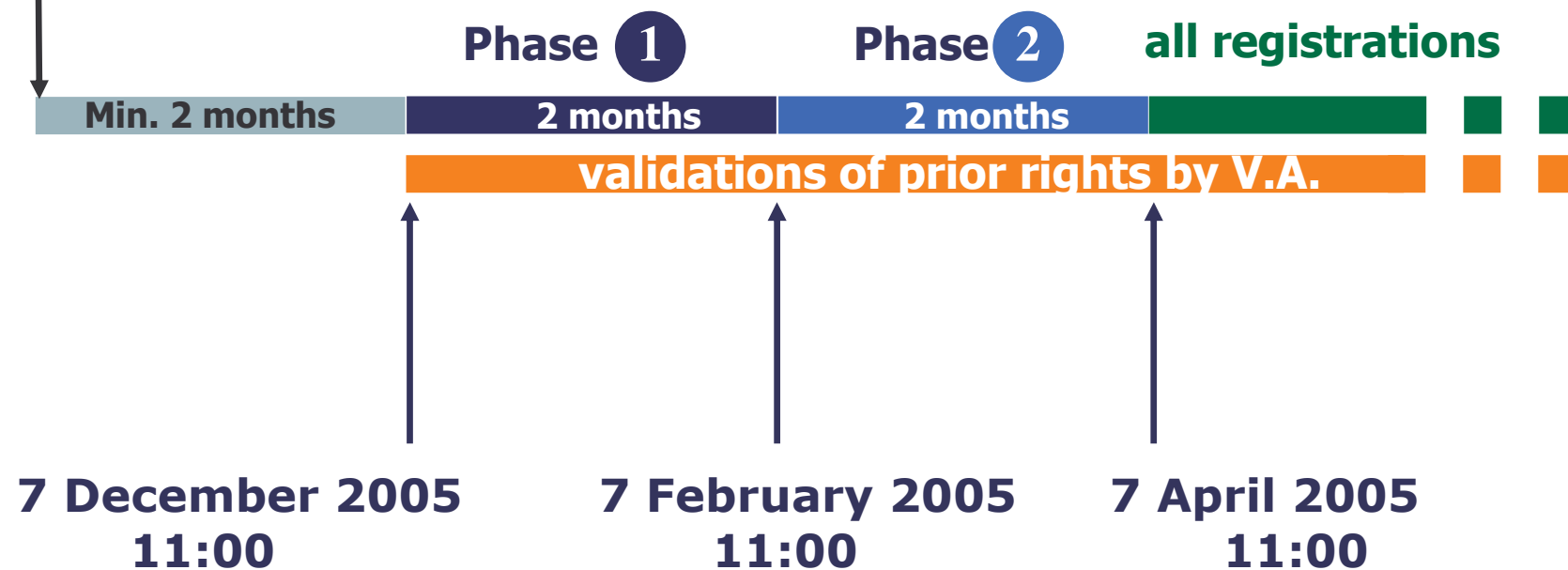

REGISTRARS

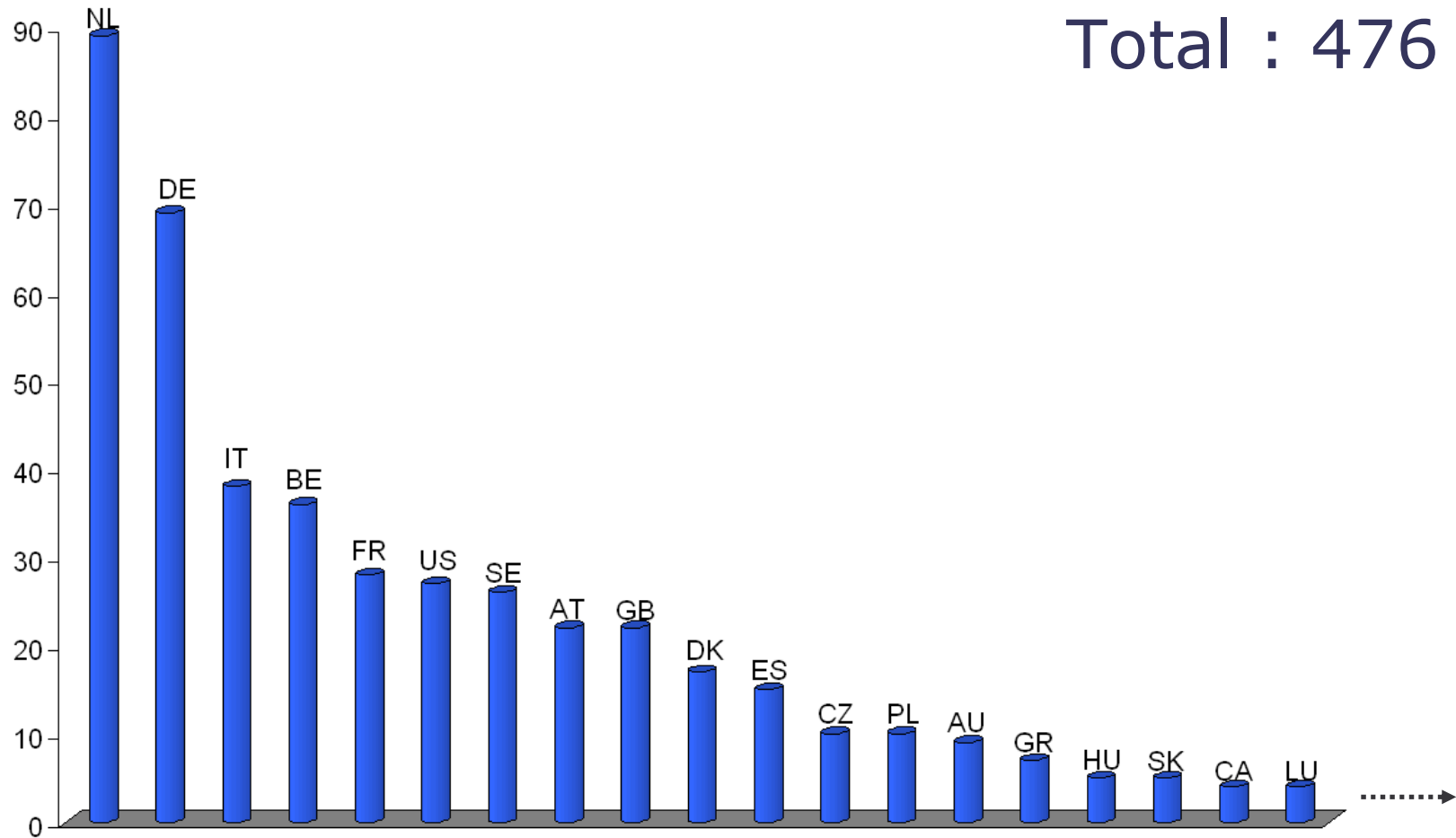

Message

- o .eu is around the corner
 - o Launch **7 DECEMBER 2005** !!
- o a EUROPEAN (INTERNET) IDENTITY for everybody
- o Be prepared : first-come-first-served
 - o Know what to do
- o Unique Protection of domain name holders
 - o Sunrise period
 - o Alternative Dispute Resolution
 - o Controled procedures for transfer of domain names

Your European Identity

Validation Services for EURid Dot-eu Sunrise

.eu Sunrise: General

Objective of .eu Sunrise:

- avoid “cybersquatting”
 - registration of someone else’s trade mark, trade name, company name without any legitimate interest and/or in bad faith
 - selling registered domain names to owner of prior rights to such name at excessive prices

Proposed approach by European Commission:

- holders of “prior rights” benefit from a “pre-registration” period, before general registration of .eu domain names starts

.eu Sunrise = Phased Registration

Two Phases

- Phase 1: holders (and licensees) of registered trade marks, geographical indications or designations of origin and public bodies
 - December 7, 2005 – February 6, 2006
- Phase 2: holders entitled in Phase 1 + holders of other types of prior rights
 - February 7, 2006 – April 6, 2006

During Sunrise, domain name applicants must:

- apply for a domain name with EURid
- provide evidence to PricewaterhouseCoopers that they have a prior right to such name

Role of PricewaterhouseCoopers as EURid's Validation Agent

Documentary evidence submitted will be validated by PricewaterhouseCoopers

- appointed as validation agent by EURid because of
 - expertise in intellectual property rights
 - efficiency in processing
 - coverage of 20 official languages in all EU member states
 - use of state-of-the-art technology solutions
- verify whether a prior right to a name exists

Domain name applications and documentary evidence must be in line with Sunrise Rules

- drafted by PricewaterhouseCoopers in consultation with European Commission and interested parties

Contact Details

PricewaterhouseCoopers
Wim Van den Bossche
Bart Lieben
Gen. Lemanstraat 67
2018 Antwerpen
Belgium

wim.van.den.bossche@pwc.be
bart.lieben@pwc.be

web site:
<http://validation.pwc.be>

general e-mail:
validation@pwc.be



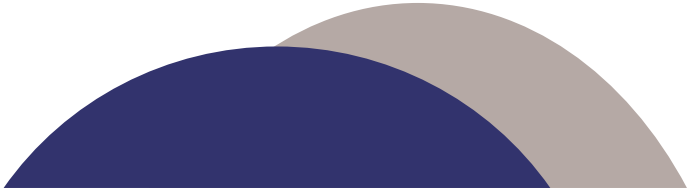

Your European Identity